

COMMERCIAL LINE

# DUPLEX **Silent-N**



**Alupera**<sup>®</sup>

## DUPLEX Silent-N

The philosophy of the brand new patent-protected units **DUPLEX Silent-N**, as the name suggests, is based on noise muffling immediately behind the ventilation unit. The design of the units with integrated noise silencers allows installation directly above the installation shafts of apartment buildings. This eliminates long ducts on roofs, reduces heat loss and significantly reduces maintenance costs. The units are equipped with completely new plastic counter-flow heat recovery exchangers **ATREA S4 and S5**. They are mainly used in central ventilation systems of apartment and industrial buildings, where the connection to the first apartment or office is usually 2 meters behind the unit.

DUPLEX Silent-N are only available in rooftop version, in two sizes, **DUPLEX 1400 Silent-N** and **DUPLEX 2400 Silent-N** in left or right configuration.

Today, production in accordance with the hygienic standard VDI 6022 and the EU Commission Regulation (1253/2014) on Ecodesign 2018 is a matter of course. Our updated selection software is available with units already fully integrated.

DUPLEX Silent-N  
(rooftop)



*Ventilation with heat recovery promotes a healthy environment, a comfortable feeling inside the building and saves energy.*





## DUPLEX Silent-N

- Heat recovery efficiency up to 93 %  
– superior counter-flow heat exchanger
- Compact size with built-in noise silencers
- Wide variability
- Elegant design
- Possibility of built-in heating
- Comfortable cooling mode at night in apartment buildings
- Eliminates major problems of central rooftop units (long ducting along the roofs of multi-storey apartment buildings)
- Ideal location of the units directly above the installation shafts
- Internet interface as standard (RD5)
- A major decrease in servicing costs
- Unit casing with excellent thermal parameters
- EC type fans – top German quality
- Smart phones application
- BMS compatibility
- 100% by-pass
- Constant airflow and pressure control
- Hygiene version according to VDI 6022
- The units meet requirement in accordance with Commission regulation (EU) No. 1253/2014 (Ecodesign)



**Voluntary** German certificate TÜV SÜD, which assesses **compliance with the German standard for the hygiene of ventilation units** and meets the requirements of standard VDI 6022: Hygienic requirements for ventilation and air conditioning systems and equipment. The hygienic inspection includes a visual inspection of such places and parts of the air handling units that can be described as sensitive and problematic from the point of view of hygiene. DUPLEX Silent-N units comply with the requirements of VDI 6022.



European Commission Regulation (EU) No. 1253/2014 (Ecodesign) implementing Directive 2009/125 / EC of the European Parliament and of the Council, defines minimum requirements for the **ecological design** of electricity consuming equipment. Strict requirements for the technical parameters of air handling units are set in order to reduce their energy consumption and improve the impact on the environment without disproportionately high costs. All DUPLEX units are designed and manufactured in accordance with the Ecodesign Regulation, which **is mandatory** in all European Union countries.



The compact ventilation units with heat recovery **DUPLEX 1400–2400 Silent-N** are, thanks to their top properties, predestined for the widest range of use in all types of buildings.

These units are characterized by a very steep characteristic and very low power consumption – thanks to a top EC fans.



## DUPLEX Silent-N

 **Rooftop configuration** with built-in silencers for maximum noise elimination

- ❑ Up to 93 % heat recovery efficiency thanks to ATREA S4 / S5 counter-flow exchangers
- ❑ Reducing energy costs
- ❑ Airflow performance – 1400 and 2400 m<sup>3</sup>/h
- ❑ Ideal for combination with SMART or EASY Boxes
- ❑ Suppression of thermal bridges (class TB1)
- ❑ Easy installation on site, including leveling and device stabilization
- ❑ Excellent thermal insulation of casing (class T2)
- ❑ Insulated base frame including silencers and vibration isolators
- ❑ Optional built-in electric PTC pre-heater
- ❑ Automatic frost protection as standard
- ❑ EC type fans (Ziehl Abegg)
- ❑ Low energy consumption
- ❑ Best available acoustic parameters in class
- ❑ Cassette filter class ePM10 50 % (M5) or ePM1 55 % (F7)
- ❑ Low investment costs
- ❑ Low weight – 225 kg / 330 kg
- ❑ Several types of sophisticated fully built-in control systems according to the application complexity
- ❑ The significant compactness of the new unit types guarantees space savings of up to 60 % compared to modular units
- ❑ Fully integrated into the ATREA selection software

## DUPLEX Silent-N

performance graphs

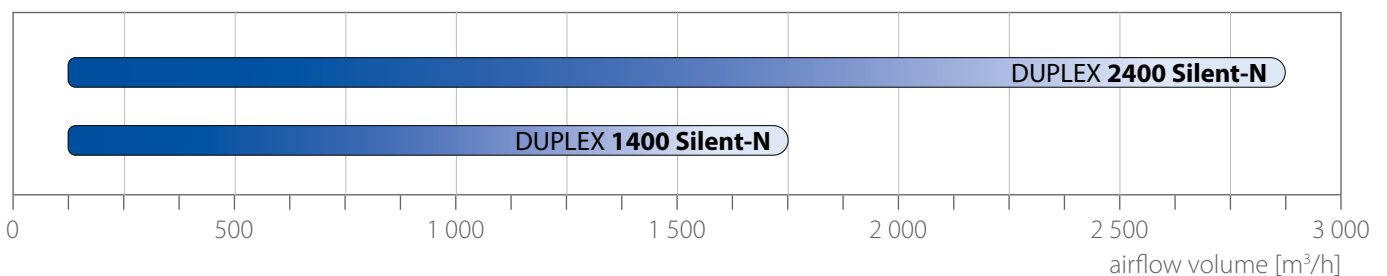

# DUPLEX Silent-N

1400, 2400



## DUPLEX Silent-N

### Construction of units

DUPLEX Silent-N units differs from other series in the placing of spigots for duct connection. Silencers are then placed between the unit and ducts. This is an original solution, which guarantees noise attenuation and does not require ducting on the roof of the building. Complete accessories are available for the unit and it is not necessary to deal with deliveries from other suppliers.

The unit can be divided into a fan section (fans for supply and exhaust placed side by side), heat recovery section and ducting connection section. Thus, the mounting of the supply fan itself significantly contributes to the reduction of the noise.

On site, the unit is assembled into a common base frame and looks as a single set.

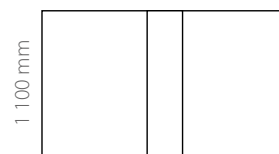
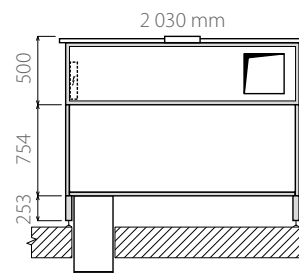

DUPLEX 1400 Silent-N

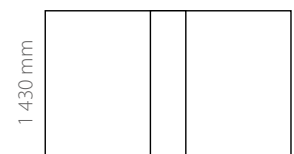
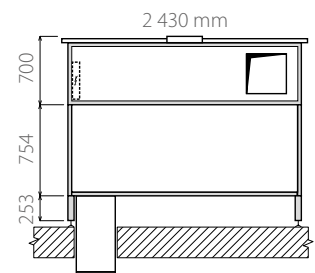

DUPLEX 2400 Silent-N



## CENTRAL VENTILATION SYSTEM

### Central ventilation system with DUPLEX Silent-N units:

All type of building, which are nowadays reconstructed or built with an emphasis on low energy consumption, are exposed to the need of controlled ventilation.

Not only for industrial buildings, apartment buildings or schools, the ATREA central system brings a comprehensive and technically sophisticated solution.

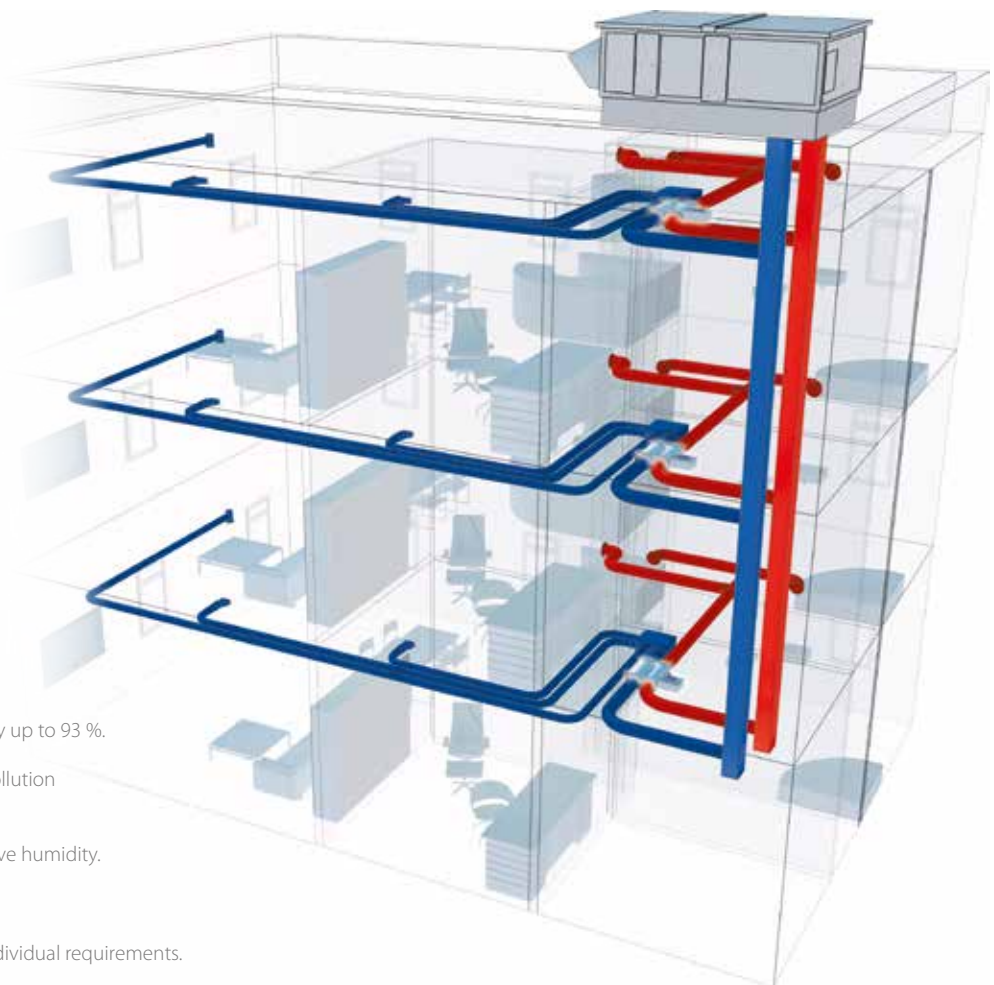

- **Saves** energy with heat recovery of efficiency up to 93 %.
- **Protects** interior from dust, pollen and noise pollution from the outdoor environment.
- **Extracts** indoor air including odors and excessive humidity.
- **Decreases** risk of moisture and mold in buildings.
- **Provides** hygienic air exchange according to individual requirements.

**DUPLEX Silent-N are standardly combined with VAV boxes, where each box controls the air flow for its space (eg apartment or classroom).**



## CENTRAL VENTILATION SYSTEM

### EASY Box

OPTIONAL  
ACCESSORIES



**Switch contact**  
eg switch, signals from lights,  
hood operation, or motion sensors, etc.



**Air quality sensor (2 independent inputs)**  
eg CO<sub>2</sub> or humidity sensor with continuous output



**Air heating**  
electric heater



**Unit control**

### SMART Box

OPTIONAL  
ACCESSORIES



**Switch contact (up to 3 independent inputs)**  
eg switch, signals from lights,  
hood operation, or motion sensors, etc.



**Air quality sensor (2 independent inputs)**  
eg CO<sub>2</sub> or humidity sensor with continuous output



**Control dampers (2x)**  
allows zoning of the supply and / or exhaust



**Air temperature treatment**  
water or electric heating, eventually cooling



**Unit control**

## BASIC CONFIGURATION

### Unit connection detail

From the unit, the outlets are led directly down to the central risers of the ducting. Thanks to this, it is not necessary to design the ducting along the roof (crossings and space for duct lines; acquisition of material for duct lines; it is necessary to insulate and eliminate heat losses and gains in winter and summer).

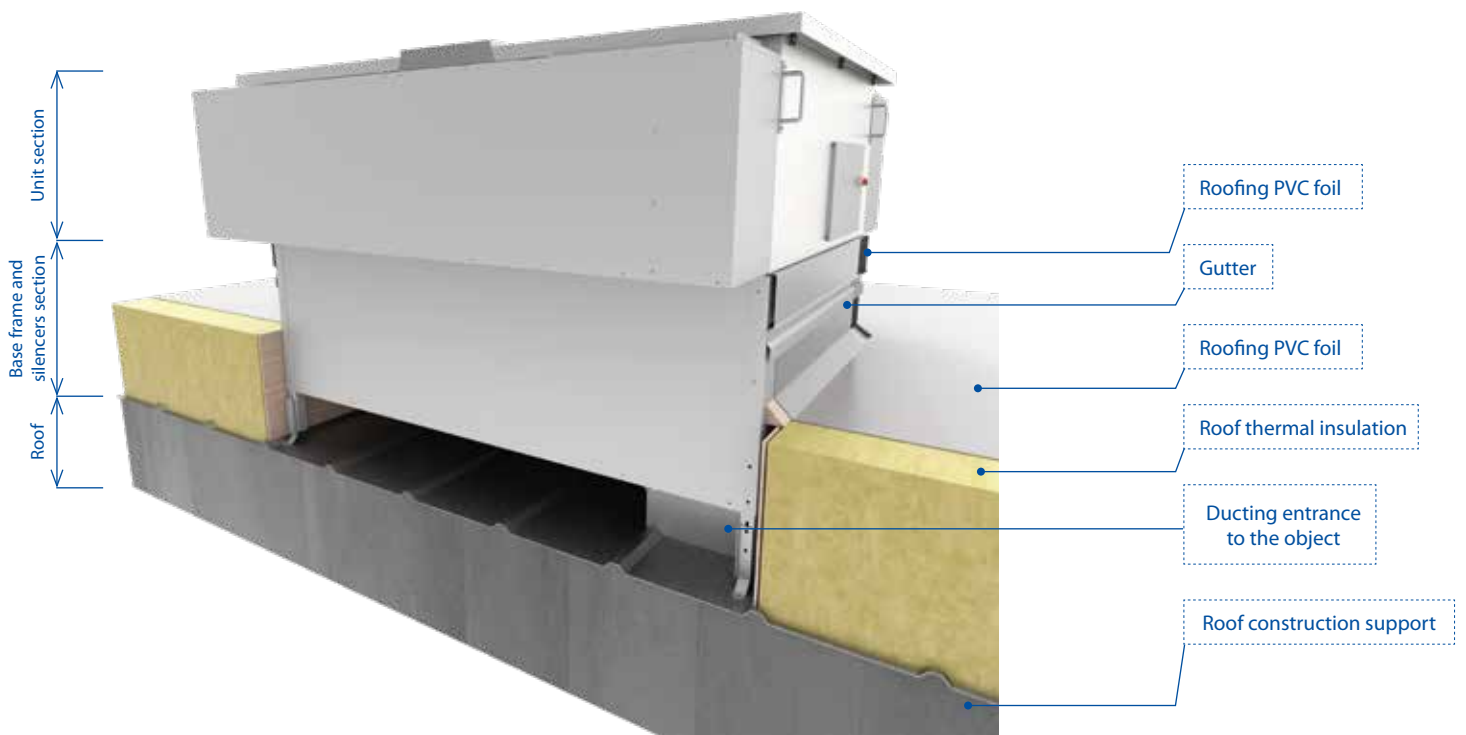





## UNIT EQUIPMENT

### DUPLEX 1400-2400 Silent-N unit

The compact ventilation unit contains a supply and exhaust fan with free-running wheel incl. anti-vibration mounting, a removable counter-flow heat recovery exchanger made up from thin-walled plastic panels, slide-in supply and extraction air filters class ePM10 50 % (M5) or ePM1 55 % (F7) and a drain pan with DN 32 hose for condensate drainage. It has a top panel for access to all built-in equipment, and a side panel to facilitate condensate drain handling and provide access to the control system.



### Fans

All DUPLEX Silent-N units have highly efficient fans (Ziehl Abegg) with free-running wheel and backward-curved blades. All fans in the DUPLEX 1400, 2400 Silent-N series comply with the requirements of European standard ErP 2015.



### Heat recovery exchanger

The units have a high-efficiency heat recovery exchanger of completely new design, made up from thin-walled plastic plates, with high heat recovery efficiency of up to 93 %.



### By-pass damper

A plate heat recovery exchanger by-pass including servo drive. When the by-pass opens, flow through the heat recovery exchanger automatically closes and no heat transfer takes place.



## EC type FANS

Fans from the world's top producer Ziehl-Abegg and ebm-papst. The outstanding German quality helps eliminate servicing costs. DUPLEX Silent units use backward bending blades fans to ensure great SFP. ▶

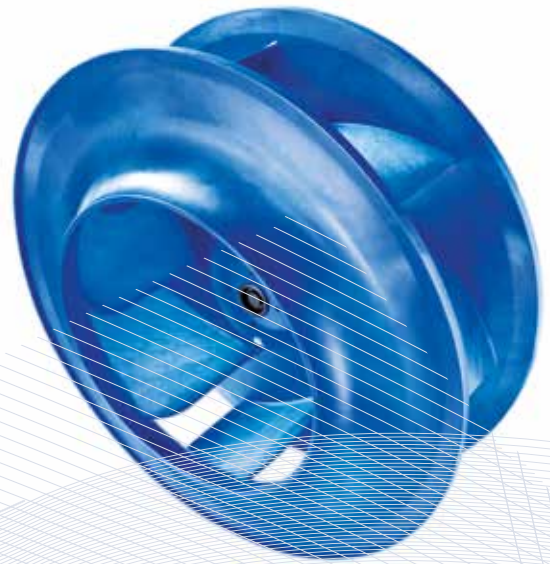

## OPTIONAL ACCESSORIES

### Base frame incl. e<sub>2</sub> (SUP) and i<sub>1</sub> (ETA) silencers

Base frame incl. insulation, duct extensions, adjustable fittings with vibration isolators and inspection holes. The casing made from galvanized metal sheet without surface treatment, intended for additional covering of roofing foil on the construction site. The inlet and outlet silencer is part of the base frame. The basic configuration of the unit always consists of two sections of two pieces, which are freely stacked on the top of each other. The design is a combination of a baffle and an absorption sound attenuators.



### Filtration ePM1 55 % (F7)

Class ePM1 55 % (F7) filter can be ordered separately.



### Electric preheaters E

Electric air preheaters made from PTC cells, designed for installation in the unit. A specific types is intended for specific unit only. The set contains all the necessary control and protection elements.



### Shut-off dampers

Shut-off dampers are installed on the inside of the ports. The dampers are supplied with two servo drive types – standard type LM 24A and the LF 24 type with emergency function for closing in the event of a power cut.

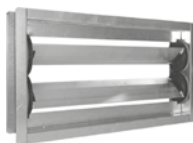

### Flexible flanges

Ports can be optionally supplied with flexible flanges.



### Electric heaters EPO-V

Separately supplied electric heaters for round or rectangular ducting to be connected to the DUPLEX units. The performances and diameters can be found in separate technical catalogues.



### Hot water heaters TPO

Separately supplied duct heaters for connection to DUPLEX units. The heaters include a vapor/gas capillary thermostat as a standard feature. For power and diameters see separate technical catalogues.



## BASE FRAME

The unit construction has an adjustable end for alignment to the correct position. They are equipped with vibration isolators that prevent the transmission of vibrations to the building structures. The base frame includes silencers as standard to achieve excellent acoustic parameters. ▶



## OPTIONAL ACCESSORIES

### Control manifolds for hot-water air heaters RE-TPO

They are intended to control the heating performance of the hot-water heaters. They always consist of a three-speed pump, two shut-off ball valves and a three- or four-way mixing manifold with a Belimo servo drive.



### Heads

Combined inlet / outlet heads to be installed onto external sound attenuators.



### Inclined manometers

A filter accessory for the easy visualisation of current pressure loss of the filters. Inclined manometers are mandatory for the hygiene version of the units under VDI 6022.



### External sound attenuators $e_1$ (ODA); $i_2$ (EHA)

External sound attenuators are designed for easy installation on the side of suction or discharge ports of Silent units to reduce the emissions of acoustic parameters.



### Constant flow and pressure control

Manometers detecting pressure at fans in combination with the control system for intelligent control of fans in order for them to run at preset flow rates.



### Spare filter cassettes

Sets of spare filter cassettes in sizes as per the unit type. They are supplied in filter classes ePM10 50 % (M5) and nebo ePM1 55 % (F7).



### Special covers

Covers for inlet ( $e_1$ ) and outlet ( $i_2$ ) ports. The cover for port  $e_1$  is supplied in conjunction with a built-in droplet eliminator.





## CONTROL SYSTEMS



### CPM CONTROL SYSTEM

#### CPM control system with CP 10 RA controller basic controller

- Manual or automatic mode
- Continuous fan control
- Automatic by-pass damper control
- Anti-freeze heat recovery exchanger protection
- Switching of external electric or built-in water heater
- Switching for selected performance according to an external signal
- Automatic operation according to sensors (CO<sub>2</sub>, RH) with 0–10 V output
- Control of the intake and outlet lock dampers
- Settings for minimum and maximum allowed revs
- Optional connection of CO<sub>2</sub> or rH sensor – max. 2 sensors with a switch or 0–10 V output
- Outputs for electric preheater and heater control (pulse 10 V) or hot-water control (0–10 V)

#### CPM control system with CPM controller comfortable controller

- + Graphic touchscreen controller
- + Weekly program
- + “Party” mode – when a higher ventilation performance is requested
- + “Vacation” mode – automatic activation and deactivation according to a set date
- + Warns when the filters need to be changed
- + Automatic operation on a constant output signal – e.g. constant pressure control

#### CP 10 RA controller



#### CPM controller

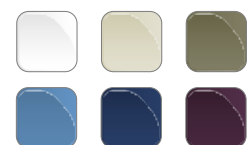

CPM color variations



## CONTROL SYSTEMS



### RD5 CONTROL SYSTEM

„high-tech“ control system line with all comfort and possibilities

#### ● CP Touch controller (touchscreen)

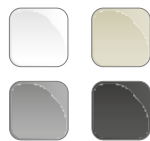

CP Touch color variations

#### ● Control via internet



#### ● Smartphone application



#### INTEGRATED WEB SERVER AS STANDARD \*

A service technician is able to remotely check the setting, check any defect and promptly fix the problem.

- Remote software update with preserving user settings.
- Show error messages, including history.
- Intuitive and user friendly interface with display both basic and servis parameters.

#### Various functions of the RD5 control system:

- **Constant flow** – An option to fit sensors for constant flow control.
- **Constant pressure** – An optional accessory for constant pressure control.
- **CO<sub>2</sub> sensors, relative humidity sensors and air quality sensors** – An option to set the intensity of ventilation automatically based on those parameters.
- **Modbus TCP** – Communication with a higher-ranking system for BMS.
- **User preferences** – including setting weekly programmes for ventilation, heating and cooling modes. Immediate manual override settings for more convenience to the user as well as weekly programme control.
- **External inputs function** – ventilation switches as required.
- **Combined heating and preheating** (electrical or water based)
- **Zoning** – the ability to split the building into zones and define their operation.
- **BACnet / KNX** – optional converter enables connection to the superior system via BACnet or KNX protocol.

(\*) with RD5 control system



## SELECTION SOFTWARE

[www.atrea.com](http://www.atrea.com)

ATREA offers its proprietary design software that is a highly useful and practical tool to select DUPLEX series units and provides great marketing support!

**Very positive feedback from designers of all over Europe gives a good opportunity to easily include ATREA's units in all kinds of projects.**

Very detailed calculations on all specifications are standard.

The software checks whether all components were selected and whether the selected system is working. This way you can avoid any possible mistakes.

### It includes:

- Selecting a unit and its accessories
- Showing parameters of the selected appliance
- An option to adjust the various parameters, designs or mounting positions of the units
- Selecting the control system with accessories in a functional set
- Electrical wiring diagrams
- Displaying and printing the components installed, an h-x diagram and HVAC diagrams
- Price specifications of individual components
- Print output to a printer or PDF
- Exporting drawings and diagrams to DXF in 2D or 3D
- Sending the design and export by e-mail
- **Additionally, the design software includes a full catalogue of ATREA's products in PDF format.**

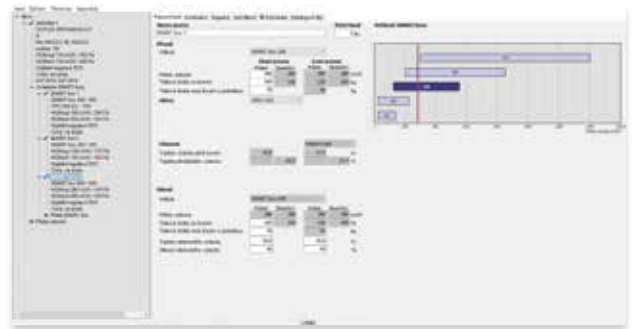



# ENGINEERING Silent

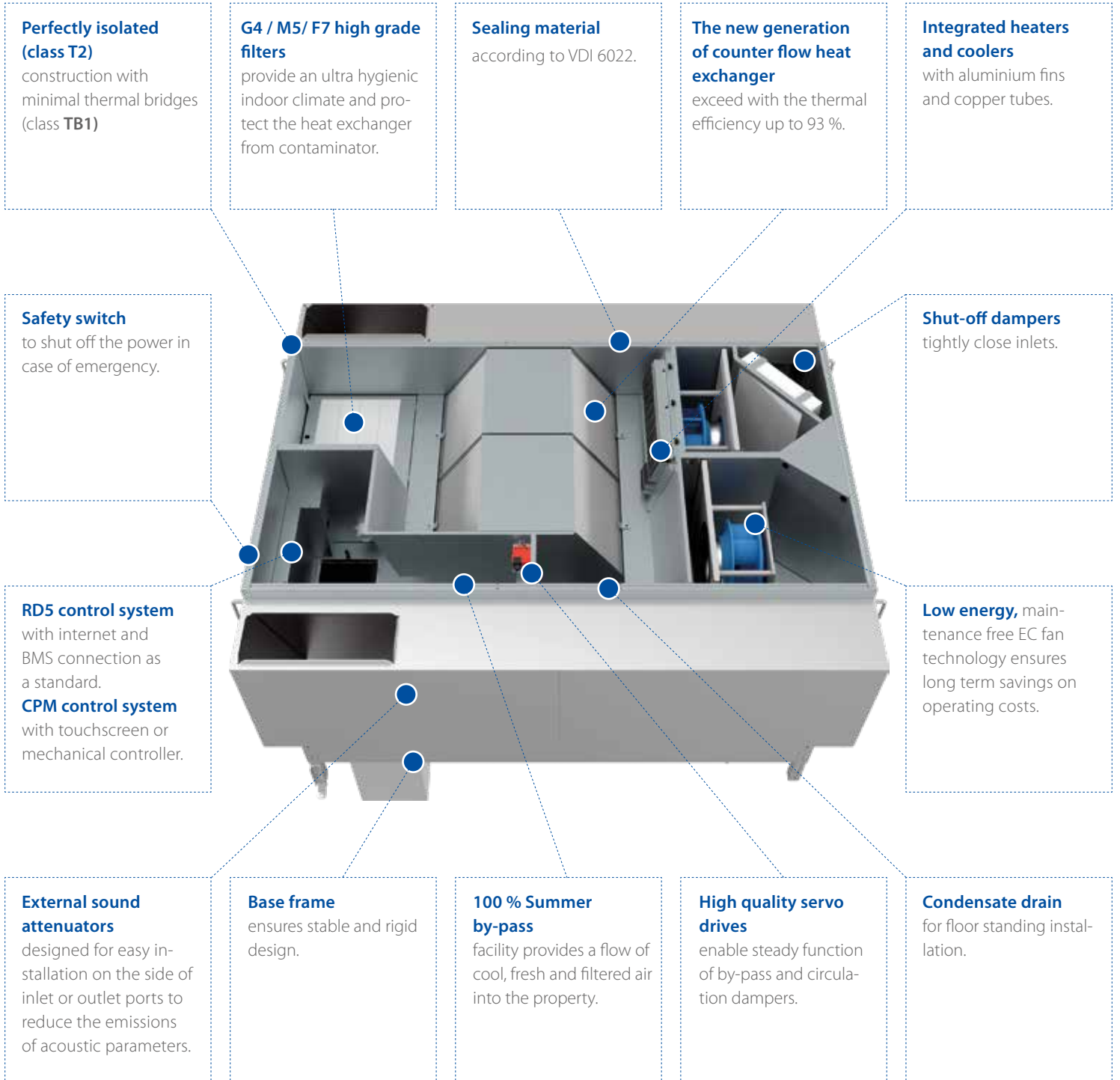



**ATREA s.r.o.**  
Československé armády 32  
466 05 Jablonec nad Nisou  
Czech Republic

email: [export@atrea.com](mailto:export@atrea.com)