

DUPLEX EC5, ECV5

Compact ventilation units
with heat recovery and EC fans
5th generation



CP TOUCH CONTROLLER

touchscreen display

setting the modes,
programming
a unit operation



CP Touch controller

low voltage cabling



Internet access

DUPLEX EC5.RD5 UNIT

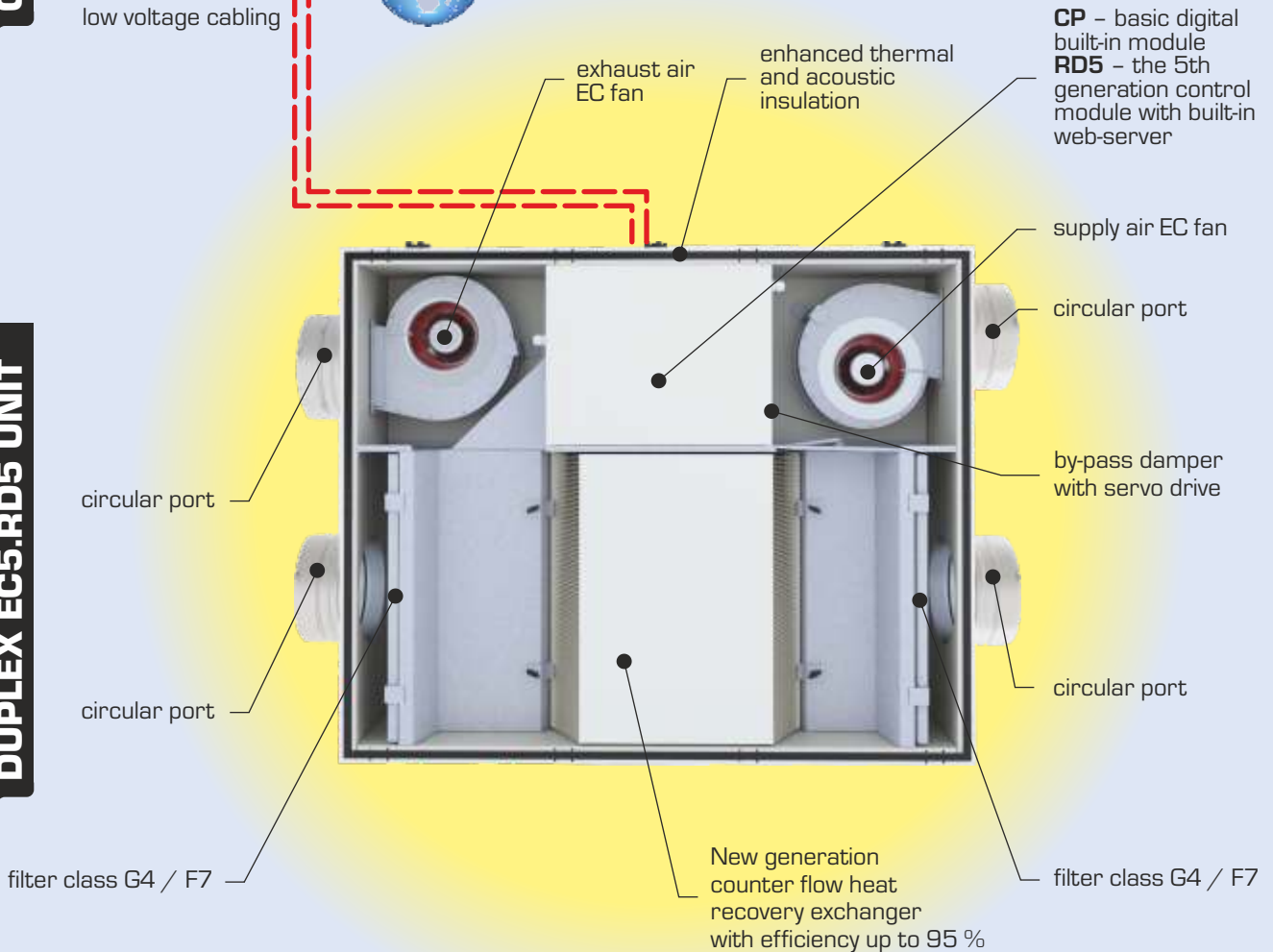

CP – basic digital built-in module
RD5 – the 5th generation control module with built-in web-server



RESIDENTIAL VENTILATION & HEATING

ATREA s.r.o., Čs. armády 32
466 05 Jablonec n. Nisou
Czech Republic



www.atrea.eu

Tel.: +420 483 368 111
Fax: +420 483 368 112
E-mail: atrea@atrea.eu

ATREA VENTILATION SYSTEM

ATREA VENTILATION SYSTEM

System description

The ventilation system provides controlled equal-pressure ventilation with heat recovery for the houses and high-rise residential buildings, together with possible reheating of the supply air, pre-cooling in summer and the effective use of all internal and external energy gains. Properly designed ventilation system provides fresh filtered air to each room and kitchen and ensures exhaust of used air from bathrooms, toilets and kitchens.

The company ATREA offers this system as a complete construction set, consisting of the following main components:

- ventilation units with heat recovery series DUPLEX EC5 and ECV5
- complete measuring and regulation system with the option to control other parts of the system (e.g. a zone butterfly valve, an earth heat exchanger etc.)
- integrated system of the ATREA air ducts and fittings suitable for all desired options

Using in low-energy and passive houses

In the **low-energy houses**, the ventilation system supplements a basic heating system (e.g. central heating units, floor heating etc.).

In the **passive houses**, built in the Czech and Slovak Republics, in addition to reheating of the supply air after heat recovery to the building, we also recommend the implementation of the additional heating system for compliance with the optimum relative humidity in the interior; thus avoiding excessive ventilation during heating. They can also be used in combination with a fireplace insert or other bivalent heat source. With higher demand on cooling or heating by the HVAC system only, it is recommended to choose the ventilation units with air circulation, e.g. the dual-zone units series DUPLEX R5.

Ventilation system design

Based on the long-term measurements and experience with the implementation of the ventilation systems in the residential buildings, the ATREA company recommends dimensioning of the ventilation performance according to CSN EN 15251 – Class 2 – see the marked part of the table below.

Legislative requirements

The ventilation units DUPLEX EC5 and ECV5 carry energy labels in accordance with EU Regulation no. 1253/2014 and 1254/2014..

Ventilation system advantages

- Ensure permanent air changes necessary for hygienic reasons with a possibility of one-off increases (e.g. by an external signal from toilets, bathrooms, kitchens or other inputs on the basis of users' immediate requirements)
- Savings on ventilation costs by up to 90 % thanks to highly efficient heat recovery exchangers
- Elimination of mold formation
- Elimination of thermal discomfort due to air supply with temperature differences kept to a minimum (again as a result of heat recovery with high efficiency)
- Utilisation of all internal and external thermal gains from the flat space for the heat recovery pre-heating of ventilation air
- The supply of perfectly filtered air (through Class G4 or F7 filters) significantly reduces the occurrence of allergies and respiratory diseases
- When the unit is set to full performance (via a by-pass), cooling is possible in summer, particularly through the supply of night filtered air
- A full-range modular system allows for easy or even DIY installation

Ventilation performance

Standard – regulation		Ventilation intensity in unoccupied rooms (h ⁻¹)	Ventilation intensity (h ⁻¹)	Volume per person (m ³ /h)	Kitchens (m ³ /h)	Bathrooms (m ³ /h)	Toilets (m ³ /h)
CSN EN 15665 – Z1	Minimum value	0,3	0,3	15	100	50	25
	Recommended value		0,5	25	150	90	50
CSN EN 15251	1st Class	0,1 – 0,2	0,7	36	100	72	50
	2nd Class		0,6	25	72	54	36
	3rd Class		0,5	15	50	36	25
CSN 73 0540 – 2		0,1	0,3 – 0,6	15 – 25	References to other regulations		

More documentation for designing a ventilation system



Mounting details



Catalogue of components



www.atrea.eu

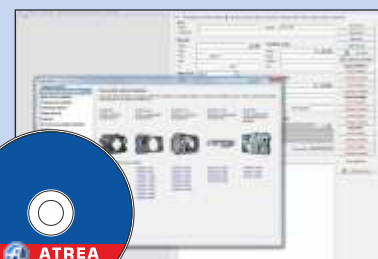

CD

Selection software

HEAT RECOVERY – WHAT IS IT?

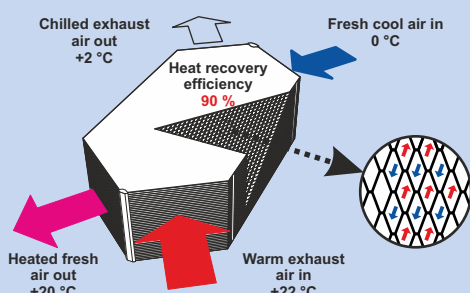

Heat recovery principle

Heat transfer occurs through the separating walls of a heat exchanger – in winter warmer exhaust air preheats colder supply air. The same principle is applied also in summer for cool recovery.

In winter time humidity condensates in exhaust air. This condensate increases heat recovery efficiency through improved heat transfer and is continuously drained into a sewer system.

Significance of heat recovery

An energy-optimised heat recovery exchanger reaches a highly economical ratio between power consumption (to run fans), air performance and heat recovery.

The fan input vs. heat recovery gain ratio during ventilation reaches an energy efficiency of 20–40, i.e. from 1 W of power used to run a DUPLEX EC5 up to 40 W is recovered from exhaust air. **Effective ratio 1 : 40**

DUPLEX EC5 / ECV5 UNITS DESCRIPTION

Intention

The new 5th generation heat recovery units DUPLEX are delivered in two basic lines: **DUPLEX EC5** for the installation under the ceiling and **DUPLEX ECV5** in the vertical design.

The units are designed for the comfort ventilation of all types of residential and public buildings, are particularly suitable for the low-energy and passive houses and the apartments in the residential buildings with the decentralized ventilation system.

Basic description

In the unit housing, made with mineral insulation with the thickness of 30 mm ($U = 0.81 \text{ Wm}^{-2}\text{K}^{-1}$) with the thermal bridges suppression and the reaction to fire class A2/A1, a swirling counterflow plastic heat recovery exchanger (efficiency up to 95 %), two ventilators of free impeller type with the electronic EC control and the possibility to supplement regulation for the control of the constant air flow, supply and exhaust air filters G4 before entering the recovery heat exchanger, an automatic butterfly valve of the by-pass, a control module and a connection terminal plate are built in. For the ceiling units EC5, condensate outlets in the doors are prepared for both operating positions of the units. Connection nozzles are round, used for connecting flexible or fixed piping with the thermal bridges suppression. Access to the unit is possible through the fully openable hinged door via the locking latches.

Units advantages

- highest energy efficiency class A+
- very low height H allowing installation in the ceiling

- standard built-in fans with free impeller type EC are characterized by very low power consumption and excellent speed regulation
- higher outputs of the units enable occasional intensive air exhaust or summer ventilation
- recovery efficiency up to 95 % due to the new generation recuperation exchangers
- excellent thermal insulation parameters of the unit housing with the thermal bridges suppression
- high sound attenuation of the unit housing due to the high density mineral insulation
- built-in by-pass is a standard part of the unit and needs no additional space; in addition, due to its construction, it ensures 100 % by-pass in the by-pass mode without mutual thermal transfer
- standardly offered two types of regulation meet all the requirements of the unit:
 - .CP – easier and cheaper basic digital control system of the units
 - .RD5 – a new digital control system, optional for installation, enables connection of a wide range of sensors and other inputs, control of the shut-off and zone butterfly valves of the distribution system, control of the heaters or the heating system of the house etc. plus it is standardly equipped with a built-in web server for the possible control via the Internet
- possibility of installation of the built-in electrical or external electrical or hot water preheaters/air reheaters
- possible mirror changes in the EC5 units to the right/left position only by setting the regulation parameter (.RD5 units) or by simple reconnection (.CP units)

INSTALLING THE UNITS

DUPLEX EC5 – under-ceiling type

New DUPLEX EC5 units have a very flat design that allows installing them into even very low suspended ceilings. The minimum requirements for suspended ceiling void heights are in the table. A plasterboard lid is fitted below the unit; in bathrooms the lid must be airtight and the entire suspended ceiling steam tight.

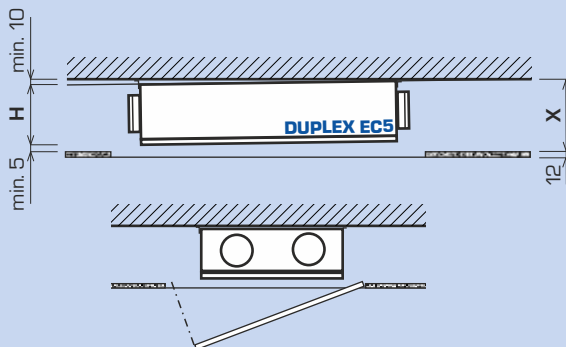

unit	unit height H (mm)	min. height of the ceiling cavity X (mm)
170 EC5	290	325
370 EC5	290	325
570 EC5	365	400

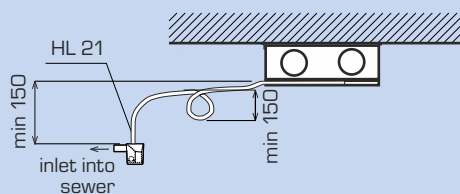

Condensate drainage

During heat recovery – heat regaining – moisture is condensed during the cooling of exhaust air. Water condensates on the walls of the heat recovery exchanger; further increasing heat recovery efficiency. Condensate runs out of the heat recovery exchanger in the direction of air being

DUPLEX ECV5 – vertical type

New vertical units DUPLEX 280 ECV5 and 380 ECV5 can be installed in narrow spaces due to their width, e.g. wardrobes with minimum internal width of 625 mm.

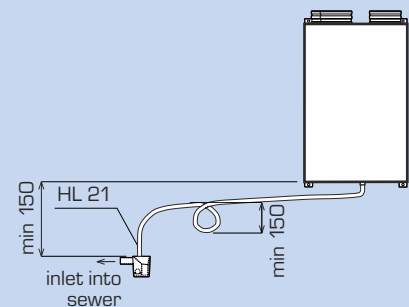
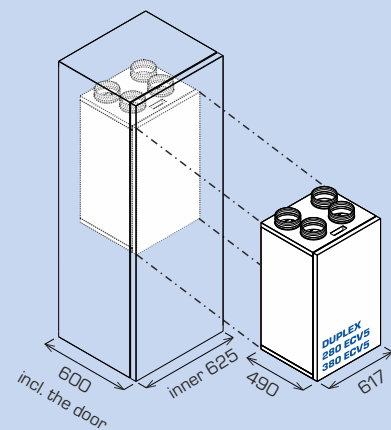

extracted and is drained from the DUPLEX unit into a sewer system. For correct functioning and drainage the unit must be separated from the sewer system using a siphon of a sufficient height, the recommended minimum being 150 mm. Small condensation drain pumps may be used.

TECHNICAL DATA – DUPLEX EC5

PERFORMANCE PARAMETERS EC5

DUPLEX 170 EC5

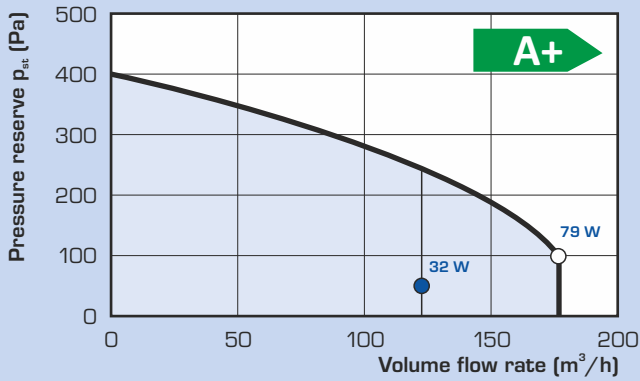

DUPLEX 370 EC5

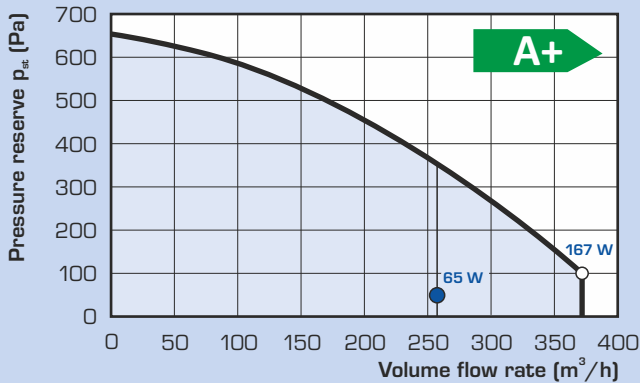

DUPLEX 570 EC5

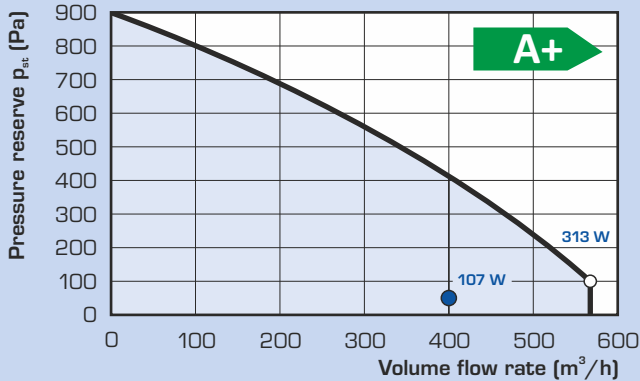

Legend:

- pressure reserve with the filter G4*
- Q_{ref} reference flow
- Q_{max} maximum flow
- * max. pressure reserve curve is indicated
- * electrical power consumption of the entire unit (both fans including the regulation) is indicated

TECHNICAL DATA EC5

DUPLEX		170 EC5	370 EC5	570 EC5
Specific energy class	-	A+ ¹⁾	A+ ¹⁾	A+ ¹⁾
Max. airflow rate ²⁾	m³/h	175	370	570
Sound power level L _{WA} ³⁾	dB	37	38	42
Max. heat recovery efficiency	%	94	95	94
Height H	mm	290	290	370
Width S	mm	655	930	930
Length (without ports) L	mm	840	1 116	1 290
Diameter of connecting ports	mm	∅ 160	∅ 200	∅ 250
Weight	kg	39	58	72
By-pass	-	Yes		
Voltage	V	230 / 50 Hz		
Supply air filter class	-	G4 (alter. F7)		
Condensate drain	mm	2x ∅ 16 (depending on position)		

¹⁾ All types of the regulation built-in in the unit standardly include a minimum of two inputs for connecting electrical signals arising as a result of human manipulation with lighting, or for connecting other devices that automatically regulate the unit output. These inputs must always be connected, or other types of sensors (e.g. CO₂, VOC, rH and the like) must be connected instead.

²⁾ The maximum flow rate is set at the pressure disposition of 100 Pa

³⁾ The stated value refers to the reference flow rate i.e. 70 % of the maximum flow rate, and to the pressure disposition of 50 Pa

SOUND PARAMETERS OF EC5 UNITS

For the sound power and pressure levels of a specific DUPLEX EC5 or ECV5 unit and an operating point selected see ATREA's selection software.

DIMENSIONAL DIAGRAM EC5

UNDER CEILING TYPE

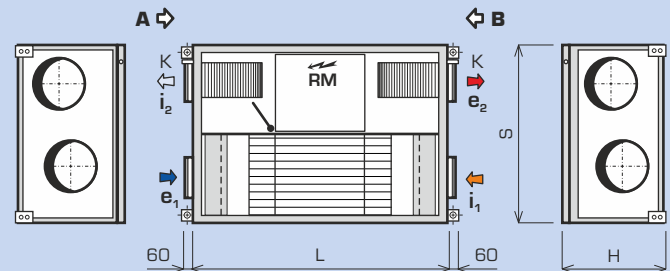

For detailed information and 2D or 3D blocks in DXF use our selection software.

EC5 VERSION

UNDER CEILING TYPE

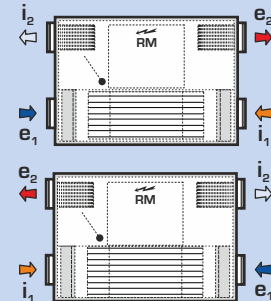

DUPLEX EC5 units are delivered in a universal position, i.e. the choice between the "right" and "left" position, as shown above, is performed by changing the regulation system parameters for the .RD5 regulation type, and by relocating the operating sensor, reconnecting the fans and relocating the by-pass thermostat for the .CP type.

LEGEND

- ➡ e₁ Fresh outdoor air inlet
- ➡ e₂ Fresh filtered air outlet
- ➡ i₁ Exhaust air inlet
- ↔ i₂ Exhaust air outlet
- RM Control module

EC5 RECOVERY EFFICIENCY

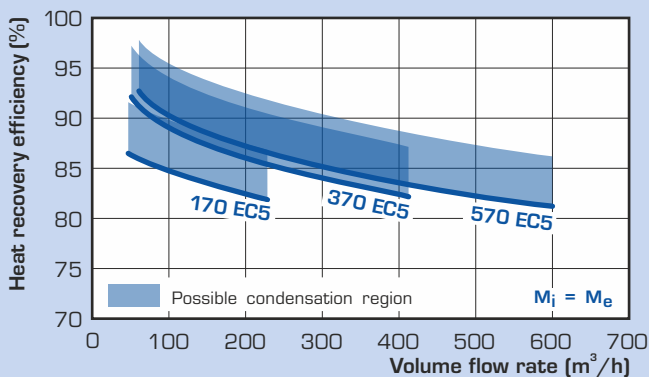

TECHNICAL DATA ECV5

DUPLEX		280 ECV5	380 ECV5	580 ECV5
Specific energy class	-	A+ ¹⁾	A+ ¹⁾	A+ ¹⁾
Max. airflow rate ²⁾	m ³ /h	285	365	565
Sound power level L _{WA} ³⁾	dB	35	36	42
Max. heat recovery efficiency	%	94	95	94
Height (without ports) V	mm	1 000	1 000	1 080
Width S	mm	617	617	928
Depth H	mm	490	490	509
Diameter of connecting ports	mm	∅ 160 ⁴⁾	∅ 160	∅ 200
Weight	kg	59	59	75
By-pass	-	Yes		
Voltage	V	230 / 50 Hz		
Supply air filter class	-	G4 (alter: F7)		
Condensate drain	mm	1x ∅ 16		

¹⁾ All types of the regulation built-in in the unit standardly include a minimum of two inputs for connecting electrical signals arising as a result of human manipulation with lighting, or for connecting other devices that automatically regulate the unit output. These inputs must always be connected, or other types of sensors (e.g. CO₂, VOC, rH and the like) must be connected instead.

²⁾ The maximum flow rate is set at the pressure disposition of 100 Pa

³⁾ The stated value refers to the reference flow rate i.e. 70 % of the maximum flow rate, and to the pressure disposition of 50 Pa

DIMENSIONAL DIAGRAM OF ECV5 UNITS

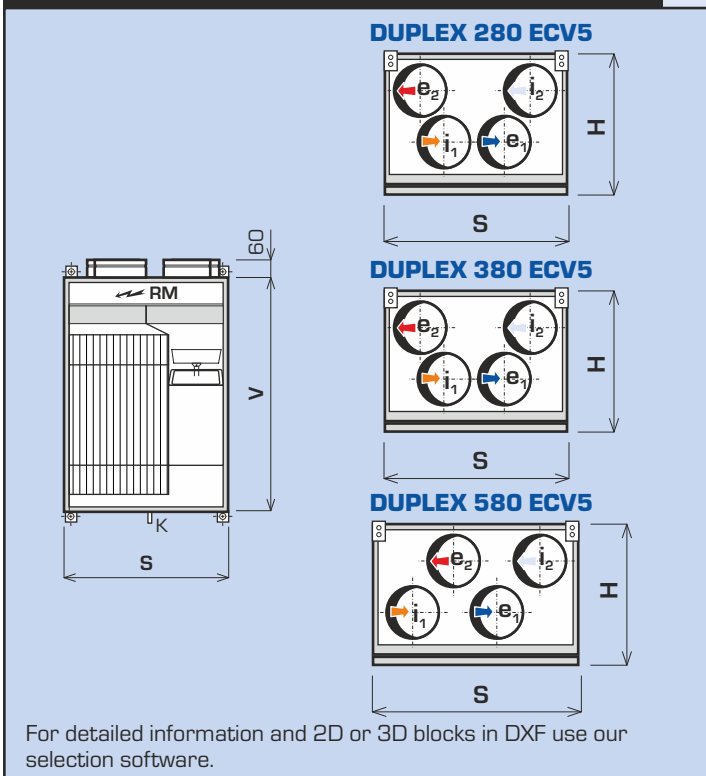

ECV5 VERSION

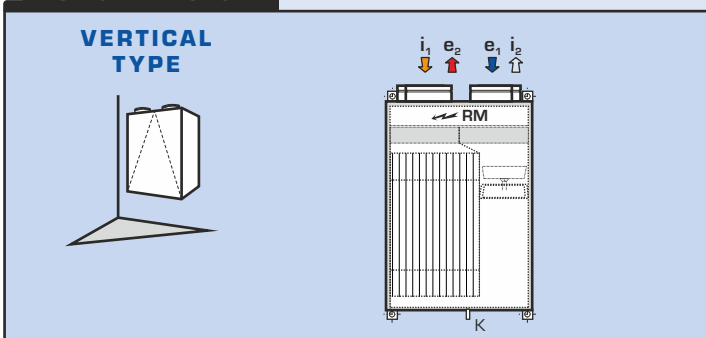

LEGEND

- ➔ e₁ Fresh outdoor air inlet
- ➔ e₂ Fresh filtered air outlet
- ➔ i₁ Exhaust air inlet
- ➔ i₂ Exhaust air outlet
- RM Control module

PERFORMANCE PARAMETERS ECV5

DUPLEX 280 ECV5

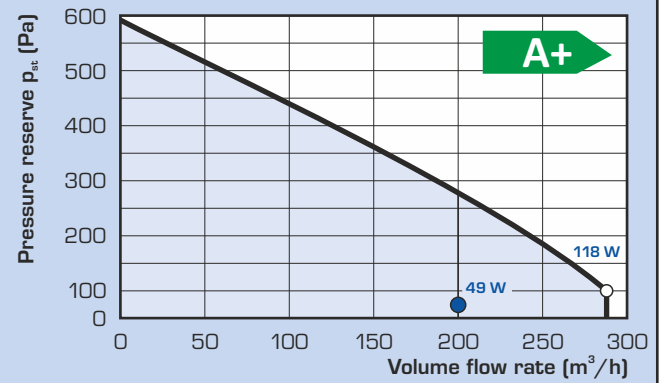

DUPLEX 380 ECV5

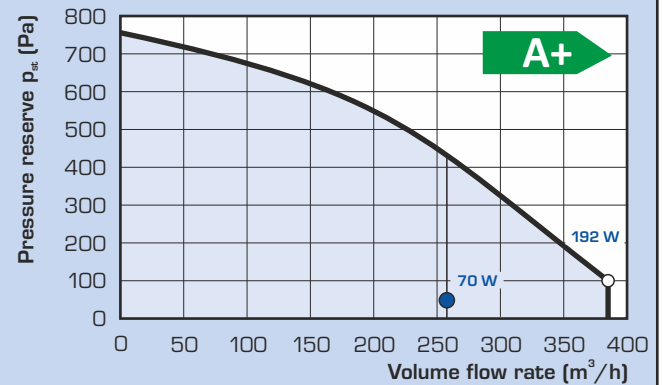

DUPLEX 580 ECV5

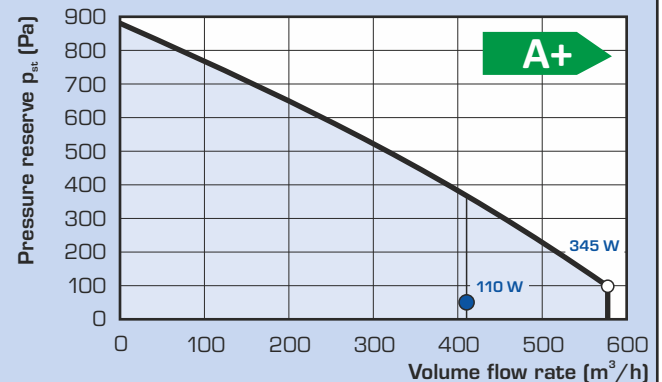

Legend:

- pressure reserve with the filter G4*
- Q_{ref} reference flow
- Q_{max} maximum flow

* max. pressure reserve curve is indicated

* electrical power consumption of the entire unit (both fans including the control system) is indicated

HEAT RECOVERY EFFICIENCY ECV5

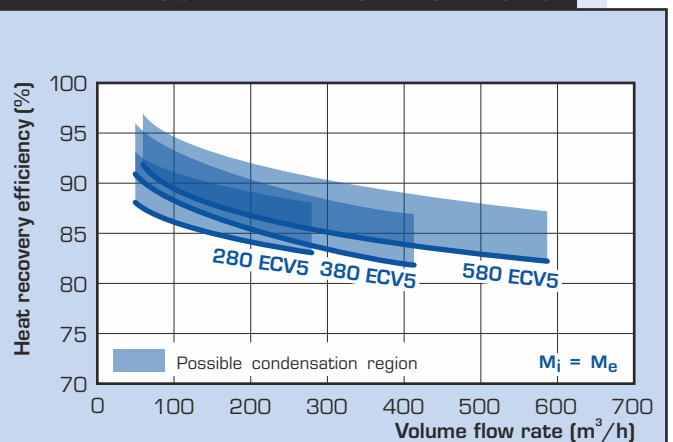

CONTROL SYSTEM

CONTROL SYSTEMS - GENERAL OVERVIEW

control system type	Performance setting range	Constant air flow control	auto. by-pass	webserver	External inputs			Control of external elements								
					Delay and run-down	Immediate start	Input 0-10 V	Shut-off dampers	Ground coupled exchanger	el. reheater / preheater	HVAC programming	hot-water heater	water cooler	zone dampers	kitchen damper	heating system
EC5.CP + CPA	10 - 100 %	—	●	—	1+n	0	1	●	—	●	—	—	—	—	—	—
EC5.CP + CPB																
EC5.RD5	10 - 100 %	—	●	●	3	1	2	●	●	●	●	●	●	●	●	●
EC5.RD5.CF																

CP CONTROL - BASIC DIGITAL CONTROL MODULE

Convenient regulation provides intuitive control and a wide range of customizable parameters. The system allows connecting of an external input to improve the ventilation performance (signals from the rooms, for example, WC, bathroom, kitchen), input 0-10 V for the performance control according to the air quality sensors (CO₂, RH). It is also possible to connect the integrated or external electrical preheater (to protect the recovery heat exchanger against

freezing) and the air reheater (to achieve the required supply air temperature). Standard regulation further provides the option to control the shut-off valves at the supply and exhaust. The uniqueness of the system is underlined by a wall **digital touchscreen CPA controller**. As an alternative of the touch controller, a **simple mechanical CPB controller** can be used.

← Required connections Optional connections →

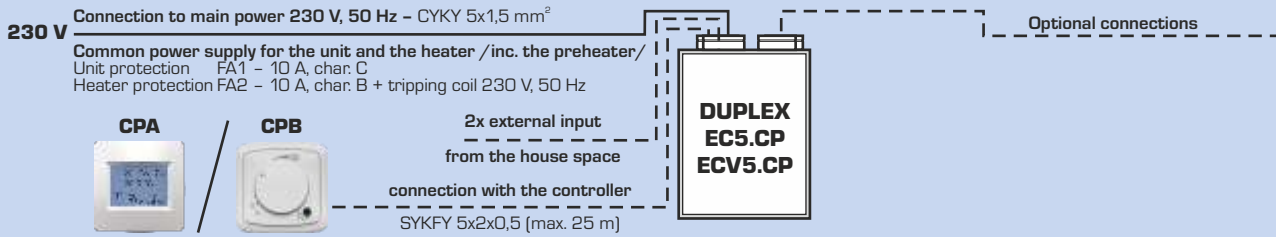

RD5 CONTROL - ADVANCED DIGITAL CONTROL SYSTEM

Basic description

Digital control module type RD5 is the most advanced method for the unit control. It provides all the basic functions and also includes a number of other inputs and outputs for connecting with optional sensors (e.g. CO₂ sensors, relative humidity sensors), signals from the rooms (WC, bathroom, kitchen), the heating systems including the shut-off valves or the shut-off butterfly valves in the distribution system. In addition, it **includes the web-server and the Internet access**.

The units with the digital module can be controlled:

- via the **controller series CP Touch** - touch colour display
- via the **controller series CP 10 RT** - mechanical controller
- without the controller, only by the voltage from 0-10 V (e.g. via the CO₂ sensor or other superior system). Control through the external signals and other automatic ventilation functions are maintained.
- through the intelligent built-in web-server - allows controlling and set-up via a web application, and is possible also for the options a), b) and c).
- through a external control system via a standard interface Modbus TCP.

Functions

The control module provides all the basic functions of the unit:

- programming of the various ventilation outputs during the day and the week
- smooth power control of both fans, with constant power function (i.e. automatic change of power to achieve the set flow rate directly in m³/h) for the CF version.
- automatic control of the by-pass butterfly valve (supply air by-pass) according to the outside air temperature
- the electric heater control (optional accessory) at a constant supply air temperature in the range of 15 to 50 °C (max. achievable temperature depends on the performance of the installed electric heater) or the control of the air temperature according to a programmed temperature difference against the required room temperature (may be automatically changed according to the settings during the day)
- switching the hot water heater (optional accessory), setting the supply air temperature by controlling a mixing node point or a hot water throttle valve 0-10 V, including the frost protection of the hot water heater (via the sensor downstream the heater ADS 120)
- switching the water cooler (optional accessory), setting the supply air temperature by control of the mixing node point or the hot water throttle valve by the signal 0-10 V, the sensor must be fitted to the pipe downstream the cooler (via the sensor ADS 120)
- the recovery exchanger frost protection

- switching to the selected output when closing through the external signal (e.g. from WC, bathroom, kitchen) with optional start and run-down
- Control of the shut-off butterfly valve at the inlet and the exhaust, and also two zone ventilation butterfly valves and one exhaust butterfly valve from the kitchen (the dampers are not part of the unit) - 24 V DC
- optional automatic operation controlled by the sensors - CO₂ concentration, relative humidity or VOC (optional accessory) - 2x input 0-10 V or the switching contacts
- according to the settings, the unit allows periodic ventilation mode - the unit is at rest and switches ventilation at set intervals
- automatic setting of the ventilation length depending on the number of persons and the building airtightness - at the periodic ventilation or when running the intermittent ventilation

Controllers

CP Touch: is intended for setting the basic ventilation modes and displaying the status of the ventilation unit including the indication of fault conditions. It allows the user access to common functions or programming of the operating modes that can be operated in the manual mode or the automatic mode according to the weekly program settings. The controller also allows setting a temporary party / holiday mode. Part of the controller is an integrated room thermostat with a weekly heating/cooling program, which can also control the simple heating system by using the functions of the control module. All values can be set on the well structured graphical touch screen.

CP 10 RT: allows mechanical setting of the ventilation output and the supply air temperature, turning the device off. Due to the built-in diode, indicates the equipment failure - flashing red, the device operation - shining green. Other programmable features are accessible only via the web interface.

CP Touch



CP 10 RT

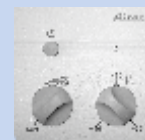

← Required connections Optional connections →

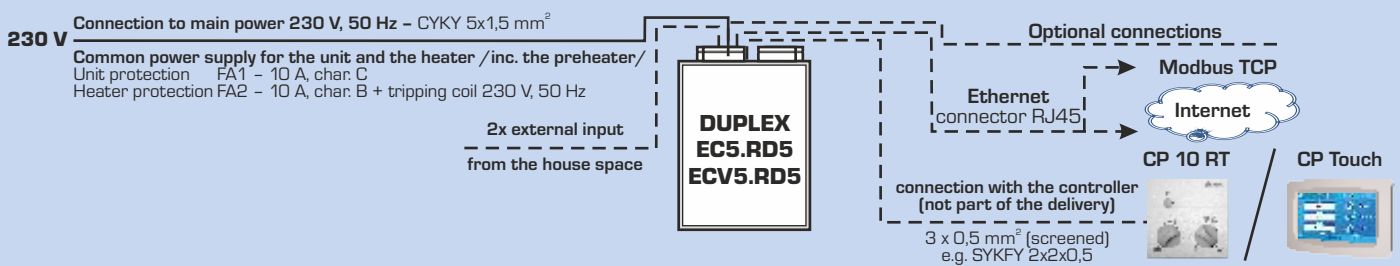

BUILT-IN ELECTRIC PREHEATERS / REHEATERS EDO - PTC

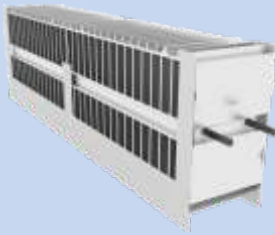

- designed for the integration into the unit, installation at a predetermined place **inside the unit** incl. the installation frame
- according to the output and the indication, the heater is designed for the supply air preheating or reheating:
 - EDO5** - heaters/preheater for the unit EC5
 - EDO5.V** - heaters/preheater for the units ECV5
 - EDO5.RD5** - heaters/preheater for the units with the RD5 control system
 - EDO5.CP** - heaters/preheater for the units with the CP control system
- operating temperature control is ensured by the unit control system

- the element is prepared for the easy installation into the unit incl. the cabling
- the heater is equipped with a non-interfering switch element SSR (for the RD5 regulation - types **EDO5-RD5**) or a switching relay (for the CP regulation - types **EDO5-CP**)
- max. temperature of the outlet air is dependent on the EDO5 output (e.g. input power 100 W increases the temperature of the supply air in the amount of 100 m³/h by max. 3 °C
- EDO5 integration directly into the unit does not reduce the unit pressure reserve
- it is equipped with two safety reverse acting thermostats 45 and 60 °C

DUPLEX unit	170 EC5 / 280 ECV5	370 EC5 / 380 ECV5	570 EC5 / 580 ECV5
Preheater EDO5	650 W	990 W	1 300 W
Reheater EDO5	250 W / 600 W	500 W / 600 W	500 W / 600 W

DUCT ELECTRIC PREHEATERS / REHEATERS EPO - V

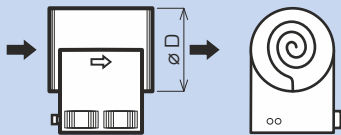

Permitted terminal board positions



Permitted flow direction

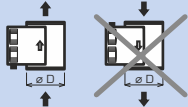

- EPO-V heaters can be combined only with the units with the RD5 control system
- used for the fresh air **preheating**, installing in the pipeline at the fresh air inlet
- used for the supply air **reheating**, installing in the pipeline downstream the unit (requires installation of the ADS 120 sensor in the pipeline downstream the heater)
- the housing is made of galvanized sheet metal
- the housing includes the terminal plate and the internal installation
- IP43 protection, installation only to normal environments

- it is equipped with two safety thermostats, a reverse acting (60 °C) and a safety irreversible thermostat (switched off at 120 °C)
- the heater is equipped with a non-interfering switch element SSR
- the safety thermostat reset button is located on the housing, during the assembly the heater must be located with regard to access and must not be fitted with a cover downward
- minimum airflow in the heater is 1.5 m/s

Type	Power input (kW)	Voltage (V)	Min. air flowrate (m ³ /h)	ø D (mm)	Recommended for DUPLEX
EPO-V 125/0,9	0,9	230	45*	125	170 EC5, 280 ECV5
EPO-V 160/1,5	1,5	230	110*	160	170 EC5, 280 ECV5, 380 ECV5
EPO-V 200/2,1	2,1	230	170*	200	370 EC5, 580 ECV5
EPO-V 250/3,0	3,0	400	260*	250	570 EC5, 580 ECV5

* If requested lower flowrate than shown here, please use the built-in EDO integrated heaters.

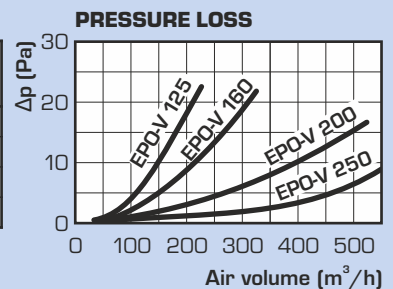

HOT WATER AIR HEATERS TPO EC THV



- Used to reheat air; to be installed in ducts (can be used only with digital control system)
- ADS 120 sensor required (to be installed in the duct downstream the heater)
- Painted metal sheet housing
- Aluminium lamellas on copper tubes

- Maximum operating pressure 10 bar
- Maximum operating temperature 70 °C
- As standard the heater includes electric choke valve with 24 V DC power supply and 0 - 10 V control

Air flow rate (m ³ /h)	Water flow rate (l/h)	Pressure loss (kPa)	Heating power* (kW)
100	30	0,1	0,3
150	40	0,2	0,5
200	60	0,3	0,8
300	80	0,6	1,3
400	100	0,9	1,9
500	120	1,3	2,5

* The table applies for heating water temperature 55 / 35 °C, supply air after heat recovery 15 - 20 °C, exhaust air min. 30 °C. Parameters for different conditions can be found using the ATREA selection software.

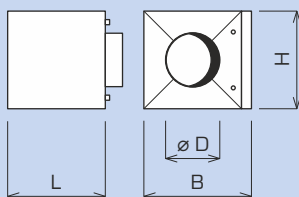

Type	ø D (mm)	B (mm)	H (mm)	L (mm)	H (")	Recommended for DUPLEX
TPO 125 EC THV	125	418	348	350	1/2"	280 ECV5
TPO 160 EC THV	160	418	348	350	1/2"	170 EC5, 380 ECV5
TPO 200 EC THV	200	418	348	350	1/2"	370 EC5, 580 ECV5
TPO 250 EC THV	250	418	348	350	1/2"	570 EC5, 580 ECV5

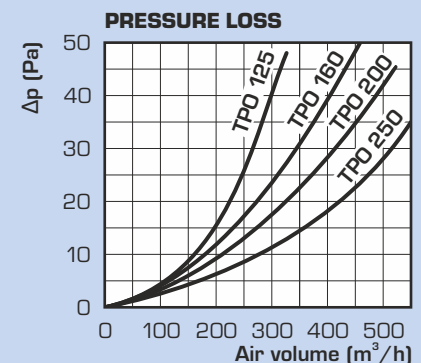

MODULAR ATREA HVAC SYSTEM

DUPLEX EC5, ECV5 UNITS



A+

DUPLEX 170 EC5.RD5	Ord. No. A160510
DUPLEX 170 EC5.RD5.CF	Ord. No. A160520
DUPLEX 170 EC5.CP	Ord. No. A160500
DUPLEX 370 EC5.RD5	Ord. No. A160511
DUPLEX 370 EC5.RD5.CF	Ord. No. A160521
DUPLEX 370 EC5.CP	Ord. No. A160501
DUPLEX 570 EC5.RD5	Ord. No. A160512
DUPLEX 570 EC5.RD5.CF	Ord. No. A160522
DUPLEX 570 EC5.CP	Ord. No. A160502



A+

DUPLEX 280 ECV5.RD5	Ord. No. A160513
DUPLEX 280 ECV5.RD5.CF	Ord. No. A160523
DUPLEX 280 ECV5.CP	Ord. No. A160503
DUPLEX 380 ECV5.RD5	Ord. No. A160514
DUPLEX 380 ECV5.RD5.CF	Ord. No. A160524
DUPLEX 380 ECV5.CP	Ord. No. A160504
DUPLEX 580 ECV5.RD5	Ord. No. A160516
DUPLEX 580 ECV5.RD5.CF	Ord. No. A160526
DUPLEX 580 ECV5.CP	Ord. No. A160505

SPARE FILTER CASSETTES



FK 170 EC5 - G4	Ord. No. A160965
FK 170 EC5 - F7	Ord. No. A160968
FK 370 EC5 - G4	Ord. No. A160966
FK 370 EC5 - F7	Ord. No. A160969
FK 570 EC5 - G4	Ord. No. A160967
FK 570 EC5 - F7	Ord. No. A160970
FK 280, 380 ECV5 - G4	Ord. No. A160971
FK 280, 380 ECV5 - F7	Ord. No. A160973
FK 580 ECV5 - G4	Ord. No. A160972
FK 580 ECV5 - F7	Ord. No. A160974

Spare air filters are delivered in package of 1 pc.

SPARE FILTER CLOTHS



FT 170 EC5 - G4	Ord. No. A160975
FT 170 EC5 - F7	Ord. No. A160978
FT 370 EC5 - G4	Ord. No. A160976
FT 370 EC5 - F7	Ord. No. A160979
FT 570 EC5 - G4	Ord. No. A160977
FT 570 EC5 - F7	Ord. No. A160980
FT 280, 380 ECV5 - G4	Ord. No. A160981
FT 280, 380 ECV5 - F7	Ord. No. A160983
FT 580 ECV5 - G4	Ord. No. A160982
FT 580 ECV5 - F7	Ord. No. A160984

Spare filter cassettes are delivered in package of 10 pcs, i.e. 5 replacements.
Carbon filter cloth to reduce odours in supply air available. Contact your supplier for information on options.

OPTIONAL ACCESSORIES - FLEXIBLE INSTALLATION

SB5 - silentblocks set	Ord. No. A160530
-------------------------------	------------------

CONTROLLERS



CP Touch controller - touchscreen - 4 colour versions (white, ivory, grey and anthracite)	Ord. No. A170130 Ord. No. A170131 Ord. No. A170132 Ord. No. A170133
---	--



CP 10 RT Controller - white colour	Ord. No. A170140 Ord. No. A170141
--	--------------------------------------



CPA Controller - exchangeable cover - touchscreen	Ord. No. A144100 colour covers see price list
--	---



CPB Controller - white colour	Ord. No. A144110
---	------------------



RD4-IO - expansion RD5 control module	Ord. No. A170285
---	------------------



RD-BACnet/KNX - expansion RD5 control module	Ord. No. A170288
--	------------------

OPTIONAL ACCESSORIES - AIR HEATERS



EPO-V 125/0,9	Ord. No. A150101
EPO-V 160/1,5	Ord. No. A150102
EPO-V 200/2,1	Ord. No. A150103
EPO-V 250/2,0	Ord. No. A150116
EPO-V 250/3,0	Ord. No. A150105



TPO 125 EC THV	Ord. No. A160212
TPO 160 EC THV	Ord. No. A160213
TPO 200 EC THV	Ord. No. A160214
TPO 250 EC THV	Ord. No. A160215



ADS 120 ADS 120 sensor is necessary for the heaters EPO-V or TPO EC THV	Ord. No. A142203
---	------------------

OPTIONAL ACCESSORIES - AIR REHEATERS



ED05 - RD5	Performance variants, see price list
ED05.V - RD5	
ED05 - CP	
ED05.V - CP	

OPTIONAL ACCESSORIES - SENSORS



HYG 6001 Room hygrostat - relative humidity sensor	Ord. No. A142303
--	------------------



ADS SMOKE 24 Cigarette smoke and air quality room sensor	Ord. No. A142311
--	------------------



ADS RH 24 Relative humidity room sensor	Ord. No. A142318
---	------------------



ADS CO₂ 24 CO ₂ room sensor	Ord. No. A142319
---	------------------



ADS CO₂ D CO ₂ duct sensor	Ord. No. A142330
--	------------------